



FIERRO Y ACERO
COFIASA

LÍDERES EN DISTRIBUCIÓN DE FIERRO, ACERO, ACCESORIOS Y MÁS...



www.cofiasa.com.mx

CATÁLOGO DE PRODUCTOS

Insumos, herramientas y accesorios para el acero.

**ESTRUCTURISTA | INDUSTRIAL | HOGAR | HERRERÍA
FERRETERÍA | AGROPECUARIO | CONSTRUCCIÓN**

¡ADQUIERE YA NUESTROS PRODUCTOS MARCA COFIASA!

La mejor calidad del mercado

DE **25 AÑOS,**
GARANTÍA

En nuestras chapas cofiasa



IDEAL
PARA CORTES
DE ACERO
AL CARBÓN
E INOXIDABLES



- Cortes más rápidos
- Mayor precisión
- 14 pulgadas

*APLICAN RESTRICCIONES

www.cofiasa.com.mx

FERRO Y ACERO
COFIASA

ÍNDICE

Placa:

Placa de Hoja	3
---------------------	---

Lámina

Lámina negra rolado en caliente	4
Lámina antiderrapante	5
Lámina negra rolado en frío	6

Lámina Galvanizada:

Lámina galvanizada ondulada	7
Lámina galvanizada rectangular	8
Losacero / lámina deck / laminacero Lámina	8

Canales	9
---------------	---

Vigas:

Viga IPS	10
Vigas IPR / Vigas W	11
Vigas IPR	12
Vigas IPR	13
Vigas IPR	14
Vigas IPR	15
Vigas IPR	16

Ángulos:

Ángulos lados iguales	17
-----------------------------	----

Soleras:

Soleras	18
Soleras	19

Varillas:

Varilla Cuadrada, Redonda Brillante	20
Semiflecha	20

HSS:

Perfiles Estructurales	21
------------------------------	----

Polín:

Polín C	22
---------------	----

PTR:

PTR	23
-----------	----

Perfiles Laminados:

Perfiles - Ventana	24
Perfiles - Ventana	25
Perfiles - Puerta	26
Perfiles - Puerta	27
Perfiles - Puerta	28
Perfiles - Puerta	29
Perfiles - Puerta	30

PTC:

PTC / Perfil rectangular	31
PTC / Perfil rectangular	32
PTC / Perfil rectangular	33
PTC / Perfil rectangular	34
PTC / Perfil rectangular	35
PTC / Perfil rectangular	36
PTC / Perfil rectangular	37
PTC / Perfil rectangular	38

Tableros:

Tableros	40
Tableros	41
Tableros	42

Tubería:

Tubería redonda - Cedulas	43
Tubería redonda - Cedulas	44
Tubería industrial	45
Tubería redonda	46
Tubería redonda	47

Aceros de Construcción

Rejilla Electroforjad	48
Varilla R-42 Castillo	49
Alambre Recocido Alambón	50
Malla Electrosoldada Armadura	51
Escalerilla	52

Tablas de Equivalencias	53
-------------------------------	----

Tablas de Equivalencias	54
-------------------------------	----

PLACA



Placa en Hoja

Espesor		Peso		Peso por Placa en Kg											
Pulgadas	mm	kg/m ²	kg/pie ²	3'x6'	3'x8'	3'x10'	4'x8'	4'x10'	5'x10'	5'x20'	6'x20'	6'x40'	8'x20'	8'x40'	
3/16	0.187	4.8	37.78	4	--	84	105	112	140	176	351	421	--	562	1,123
1/4	0.250	6.3	50.38	5	--	112	140	150	187	234	468	562	--	749	1,498
5/16	0.312	7.9	62.97	6	--	140	176	187	234	293	585	702	--	936	--
3/8	0.375	9.5	75.56	7	--	168	211	225	281	351	702	842	1,685	1,123	2,246
7/16	0.437	11.1	88.05	8	--	--	*246	--	--	--	--	*983	--	*1,315	--
1/2	0.500	12.7	100.75	9	--	225	281	300	374	468	936	1,123	2,246	1,498	2,995
5/8	0.625	15.9	125.94	12	211	281	351	374	468	585	1,170	1,404	2,808	1,872	3,744
3/4	0.750	19.0	151.12	14	253	337	421	449	562	702	1,404	1,685	3,370	2,246	4,493
7/8	0.875	22.2	176.31	16	--	--	*491	--	--	--	--	*1,966	--	*2,621	--
1	1	25.4	201.50	19	337	449	562	599	749	936	1,872	2,246	4,493	2,995	*5,990
1 1/4	1.250	31.7	251.88	23	--	562	702	749	936	1,170	2,340	2,808	5,616	3,744	*7,488
1 1/2	1.500	38.1	302.25	28	--	674	842	899	1,123	1,404	2,808	3,370	--	4,493	*8,986
2	2	50.8	403.00	37	--	--	--	--	--	--	--	*4,493	--	*5,990	--

•Estos materiales se cotizan sobre pedido

LÁMINA NEGRA



Lámina Negra Rolado en Frío

Calibre	Espesor		Kg/Hoja				Peso
	Pulgadas	mm	3'x 8'	3'x10'	4'x8'	4'x10'	Kg/m ²
16	0.060	1.524	27	34	36	45	12.09
18	0.048	1.219	22	27	29	36	9.67
20	0.036	0.914	16	20	22	27	7.25
22	0.030	0.762	13	17	18	22	6.05
24	0.024	0.610	11	13	14	18	4.84
26	0.019	0.493	9	11	11	14	3.57

• Sobre pedido

LÁMINA ANTIDERRAPANTE

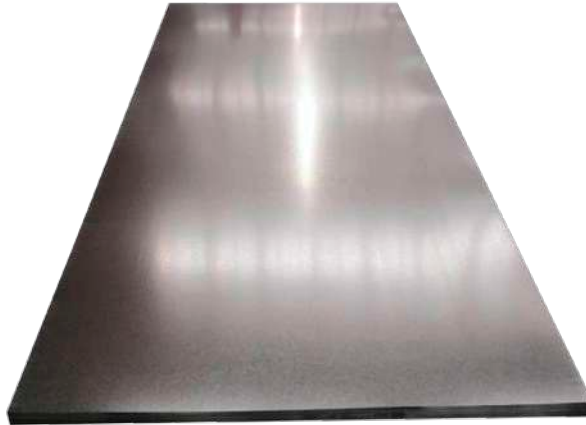

Lámina Antiderrapante

Calibre	Espesor		Kg/Hoja						Peso
	Pulgadas	mm	3'x 8'	3'x10'	4'x8'	4'x10'	5'x10'	5'x20'	
14	0.075	1.905	41	51	54	68	--	--	18.31
12	0.105	2.667	--	71	76	95	--	--	25.63
1/8	0.125	3.175	--	84	90	112	*139	*279	30.02
3/16	0.188	4.775	95	118	126	158	197	395	42.47
1/4	0.250	6.350	--	153	163	204	*255	*510	54.92
3/8	0.375	9.525	--	--	--	*297	--	--	79.82

•Sobre pedido (Se cotiza)

LÁMINA



Lámina Negra Rolado en Frío

Calibre	Espesor		Kg/M Lineal		Peso/Hoja			
	Pulgadas	mm	3'	4'	3'x8'	3'x10'	4'x8'	4'x10'
14	1.935	0.0762	13.87	18.50	34	42	45	56
16	1.557	0.0613	11.15	14.87	27	34	36	45
18	1.252	0.0493	8.97	11.96	22	27	29	36
20	0.950	0.0374	6.80	9.06	17	21	22	28
22	0.798	0.0314	5.70	7.60	14	17	19	23
24	0.569	0.0224	4.06	5.42	10	12	13	17
26	0.493	0.0194	3.52	4.69	9	11	11	14
28	0.42	0.0164	2.97	3.96	7.24	9.05	9.65	12.06

LÁMINA

T0-100 y T0-725		
Poder Cubriente		
	Muros	Cubiertas
T0-100	103.2 cm (40.6")	95.2 cm (37.5")
T0-725	71.5 cm (28.1")	

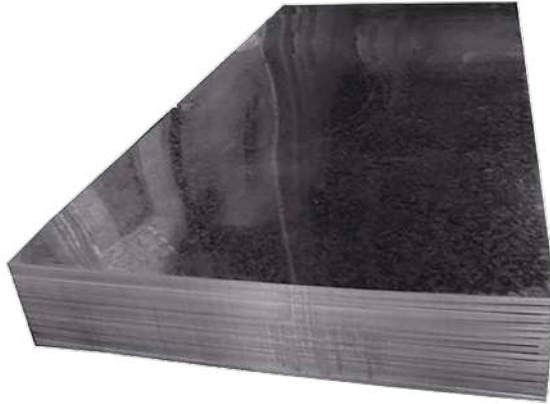

Lámina Galvanizada Ondulada

Tabla de pesos y espesores

Calibre	Espesor pulg	Peso aprox Kg/ml T0-100	Peso aprox Kg/m ² T0-100		Calibre	Espesor pulg	Peso aprox kg/ml T0-725	Peso aprox kg/m ² T0-725
			Muro	Cubierta				
					30*	0.0120 (0.3048)	2.44	3.41
28	0.0149 (0.3785)	3.96	3.83	4.15	28	0.0149 (0.3785)	2.97	4.16
26	0.0179 (0.4547)	4.69	4.54	4.92	26*	0.0179 (0.4547)	3.52	4.93
24	0.0209 (0.5309)	5.42	5.25	5.68				
22*	0.0299 (0.7595)	7.61	7.37	7.99				

* Sobre pedido

LÁMINA



Lámina Galvanizada Rectangular

TR-100 y TR-725	
Poder Cubriente	
TR-72	72.0 cm (28.3")
TR-101	100.8 cm (39.7")

Tabla de pesos y espesores

Calibre	Espesor nom acero base pulg TR-72 (mm)	Peso aprox kg/ml TR-72	Peso aprox kg/m ² TR-72	Calibre	Espesor nom acero base pulg TR-101 (mm)	Peso aprox kg/ml TR-101	Peso aprox kg/m ² TR-101
32**	0.0097 (0.2464)	2.02	2.81	30*	0.0120 (0.3048)	3.25	3.22
30	0.0120 (0.3048)	2.44	3.39	28	0.0149 (0.3785)	3.96	3.92
28	0.0149 (0.3785)	2.97	4.13	26	0.0179 (0.4547)	4.69	4.64
26	0.0179 (0.4547)	3.52	4.89	24	0.0209 (0.5309)	5.42	5.37
24	0.0209 (0.5309)	4.06	5.65	22	0.0299 (0.7595)	7.61	7.52
22*	0.0299 (0.7595)	5.71	7.93	20*	0.0359 (0.9119)	9.07	9.00



Losacero / Lámina Deck / Laminacero

Tabla de pesos y espesores

Calibre	Espesor nom acero base pulg (mm)	Peso aprox kg/ml	Peso aprox kg/m ²
24	0.0239 (0.6071)	6.15	6.72
22	0.0299 (0.7595)	7.61	8.32
20	0.0359 (0.9119)	9.07	9.91
18	0.0478 (1.2141)	11.96	13.07

CANAL

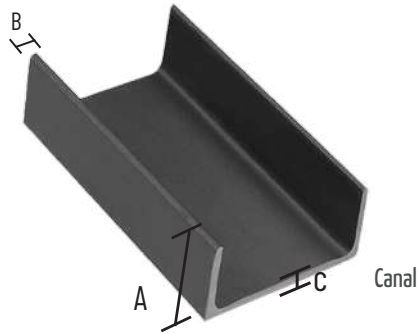

En largos de 6.10 mts en acero A-36 y 12.20 mts en acero A50

Perfil		Peso		Ancho del Patín A		Espesor del Patín B		Espesor del Alma C	
Pulgada	mm	kg/m	LBS/FT	Pulgada	mm	Pulgada	mm	Pulgada	mm
3	76.2	5.20	3.50	1.372	35	0.273	6.9	0.132	3.4
		6.10	4.10	1.410	36	0.273	6.9	0.170	4.3
4	101.6	6.70	4.50	1.584	40	0.296	7.5	0.125	3.2
		8.04	5.40	1.584	40	0.296	7.5	0.184	4.7
5	127.0	9.97	6.70	1.750	44	0.320	8.1	0.190	4.8
6	152.4	12.20	8.20	1.920	48	0.343	8.7	0.200	5.1
		15.63	10.50	2.034	51	0.343	8.7	0.314	8.0
		19.35	13.00	2.157	55	0.343	8.7	0.437	11.1
7	177.8	14.60	9.80	2.090	53	0.366	9.3	0.210	5.3
8	203.2	17.11	11.50	2.260	57	0.390	9.9	0.220	5.6
		20.46	13.75	2.343	59	0.390	9.9	0.303	7.7
		*27.90	*18.75	2.527	64	0.390	9.9	0.487	12.4
10	254.0	22.76	15.30	2.600	65	0.436	11.1	0.240	6.1
		*29.76	20.00	2.739	69	0.436	11.1	0.379	9.6
		*37.20	25.00	2.886	73	0.436	11.1	0.526	13.4
		*44.64	30.00	3.033	76	0.436	11.1	0.673	17.1
12	304.8	30.80	20.70	2.942	74	0.501	12.7	0.282	7.2
		*37.20	25.00	3.047	77	0.501	12.7	0.387	9.8
		*44.64	30.00	3.170	80	0.501	12.7	0.510	13.0
15	381.0	50.40	33.90	3.400	86	0.650	16.5	0.400	10.2
		59.53	40.00	3.520	89	0.650	16.5	0.520	13.2
		74.50	50.00	3.716	94	0.650	16.5	0.716	18.2

VIGAS

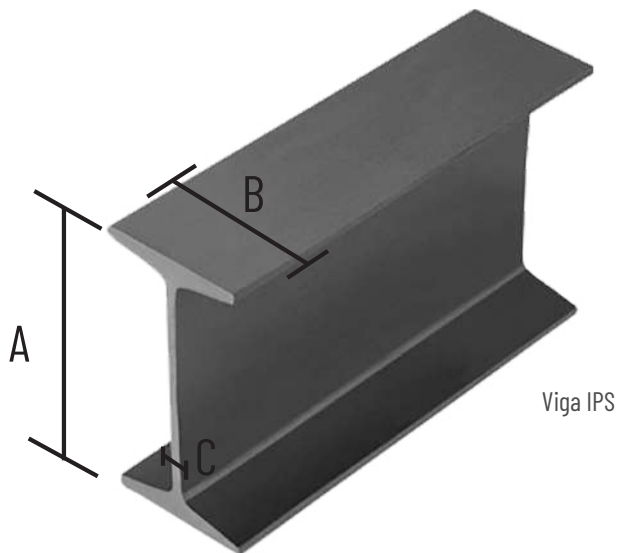

Peralte A		Peso		Ancho del patin B		Espesor del alma C	
Pulgada	mm	Kg/m	LB/FT	Pulgada	mm	Pulgada	mm
3	76.2	8.48	5.7	2.33	59	0.17	4
4	101.6	11.46	7.7	2.66	68	0.19	5
5	127.0	14.88	10.0	3.00	76	0.21	5
6	152.4	18.60	12.5	3.33	85	0.23	6
*7.87	*200.0	*26.20	*16.7	*3.54	*90	*0.27	*7
8	203.2	27.38	18.4	4.00	102	0.27	7

• En largos de 6.10 y12.20 mts en acero A-36

VIGAS

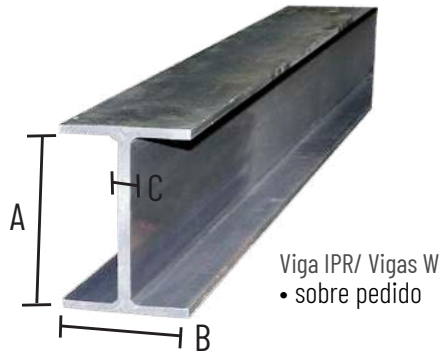

Este producto cumple con los siguientes grados de acero A36 / A572°50 / A992

Dimensiones		Peso		Peralte A		Ancho del patín B		Espesor del patín		Espesor del alma C	
Pulgadas	mm	kg/m	LB/FT	Pulgada	mm	Pulgada	mm	Pulgada	mm	Pulgada	mm
4" x 4"	101.6 x 101.6	19.3	13	4.16	106	4.06	103	0.35	8.9	0.28	7.1
5" x 5"	127.0 x 127.0	23.8	16	5.01	127	5.00	127	0.36	9.1	0.24	6.1
		28.3	19	5.15	131	5.03	128	0.43	10.9	0.27	6.9
6" x 4"	152.4 x 101.6	12.7	8.5	5.83	148	3.94	100	0.19	4.8	0.17	4.3
		13.4	9	5.90	150	3.94	100	0.22	5.6	0.17	4.3
		17.9	12	6.03	153	4.00	102	0.28	7.1	0.23	5.8
		23.8	16	6.28	160	4.03	102	0.41	10.4	0.26	6.6
6" x 6"	152.4 x 152.4	22.3	15	5.99	152	5.99	152	0.26	6.6	0.23	5.8
		29.8	20	6.20	157	6.02	153	0.37	9.4	0.26	6.6
		37.2	25	6.38	162	6.08	154	0.46	11.7	0.32	8.1
8" x 4"	203.2 x 101.6	14.9	10	7.89	200	3.94	100	0.21	5.3	0.17	4.3
		19.3	13	7.99	203	4.00	102	0.26	6.6	0.23	5.8
		22.3	15	8.11	206	4.02	102	0.32	8.1	0.25	6.3
8" x 5 1/4"	203.2 x 133.3	26.8	18	8.14	207	5.25	133	0.33	8.4	0.23	5.8
		31.3	21	8.28	210	5.27	134	0.40	10.2	0.25	6.3
8" x 6 1/2"	203.2 x 165.1	35.7	24	7.93	201	6.50	165	0.40	10.2	0.25	6.3
		41.7	28	8.06	205	6.54	166	0.47	11.9	0.29	7.4
8" x 8"	203.2 x 203.2	46.1	31	8.00	203	8.00	203	0.44	11.2	0.29	7.4
		52.1	35	8.12	206	8.02	204	0.50	12.7	0.31	7.9
		59.5	40	8.25	210	8.07	205	0.56	14.2	0.36	9.1
		71.4	48	8.50	216	8.11	206	0.69	17.4	0.40	10.2
		86.0	58	8.74	222	8.23	209	0.81	20.6	0.51	13.0
		99.0	67	9.02	229	8.27	210	0.93	23.7	0.57	14.5

VIGAS

Este producto cumple con los siguientes grados de acero A36 / A572⁵⁰ / A992

Dimensiones		Peso		Peralte A		Ancho del patín B		Espesor del patín		Espesor del alma C	
Pulgadas	mm	kg/m	LB/FT	Pulgada	mm	Pulgada	mm	Pulgada	mm	Pulgada	mm
10" x 4"	254.0 x 101.6	17.9	12	9.87	251	3.96	101	0.21	5.3	0.19	4.8
		22.3	15	9.99	254	4.00	102	0.27	6.9	0.23	5.8
		25.3	17	10.11	257	4.01	102	0.33	8.4	0.24	6.1
		28.3	19	10.24	260	4.02	102	0.40	10.2	0.25	6.3
10" x 5 3/4"	254.0 x 146.0	32.7	22	10.17	258	5.75	146	0.36	9.1	0.24	6.1
		38.7	26	10.33	262	5.77	147	0.44	11.2	0.26	6.6
		44.6	30	10.47	266	5.81	148	0.51	13.0	0.30	7.6
10" x 8"	254.0 x 203.2	49.1	33	9.73	247	7.96	202	0.44	11.2	0.29	7.4
		58.0	39	9.92	252	7.99	203	0.53	13.5	0.32	8.1
		67.0	45	10.10	257	8.02	204	0.62	15.7	0.35	8.9
10" x 10"	254.0 x 254.0	72.9	49	9.98	253	10.00	254	0.56	14.2	0.34	8.6
		80.4	54	10.09	256	10.03	255	0.62	15.7	0.37	9.4
		89.4	60	10.22	260	10.08	256	0.68	17.3	0.42	10.7
		101.2	68	10.40	264	10.13	257	0.77	19.6	0.47	11.9
		114.6	77	10.60	269	10.19	259	0.87	22.1	0.53	13.5
		131.1	88	10.84	275	10.26	261	0.99	25.1	0.61	15.4
		149.0	100	11.10	282	10.35	263	1.12	28.4	0.68	17.3
167.0	112	11.38	289	10.43	265	1.25	31.8	0.76	19.2		
12" x 4"	304.8 x 101.6	20.8	14	11.91	303	3.97	101	0.23	5.8	0.20	5.1
		23.8	16	11.99	305	3.99	101	0.27	6.9	0.22	5.6
		28.3	19	12.16	309	4.01	102	0.35	8.9	0.24	6.1
		32.7	22	12.31	313	4.03	102	0.43	10.9	0.26	6.6
12" x 6 1/2"	304.8 x 165.1	38.7	26	12.22	310	6.49	165	0.38	9.7	0.23	5.8
		44.6	30	12.34	313	6.52	166	0.44	11.2	0.26	6.6
		52.1	35	12.50	317	6.56	167	0.52	13.2	0.30	7.6
12" x 8"	304.8 x 203.2	59.5	40	11.94	303	8.01	203	0.52	13.2	0.30	7.6
		67.0	45	12.06	306	8.05	204	0.58	14.7	0.34	8.6
		74.4	50	12.19	310	8.08	205	0.64	16.3	0.37	9.4
12" x 10"	304.8 x 254.0	78.9	53	12.06	306	10.00	254	0.58	14.7	0.35	8.9
		86.3	58	12.19	310	10.01	254	0.64	16.3	0.36	9.1

VIGAS



Este producto cumple con los siguientes grados de acero A36 / A572°50 / A992

Dimensiones		Peso		Peralte		Ancho del patín		Espesor del patín		Espesor del alma	
Pulgadas	mm	kg/m	LB/FT	Pulgada	mm	Pulgada	mm	Pulgada	mm	Pulgada	mm
12" x 12"	304.8 x 304.8	96.7	65	12.12	308	12.00	305	0.61	15.5	0.39	9.9
		107.1	72	12.25	311	12.04	306	0.67	17.0	0.43	10.9
		117.6	79	12.38	314	12.08	307	0.74	18.8	0.47	11.9
		129.6	87	12.53	318	12.13	308	0.81	20.6	0.52	13.1
		142.9	96	12.71	323	12.16	309	0.90	22.9	0.55	14.0
		157.9	106	12.89	327	12.22	310	0.99	25.1	0.61	15.5
		178.6	120	13.12	333	12.32	313	1.10	28.1	0.71	18.0
		202.4	136	13.41	341	12.40	315	1.25	31.8	0.79	20.1
		226.2	152	13.71	348	12.48	317	1.40	35.6	0.87	22.1
253.0	170	14.03	356	12.57	319	1.56	39.6	0.96	24.4		
14" x 5"	355.6 x 127.0	32.7	22	13.74	349	5.00	127	0.34	8.6	0.23	5.8
		38.7	26	13.91	353	5.03	128	0.42	10.7	0.26	6.6
14" x 6 3/4"	355.6 x 171.4	44.6	30	13.84	352	6.73	171	0.39	9.9	0.27	6.9
		50.6	34	13.98	355	6.75	171	0.46	11.7	0.29	7.4
		56.5	38	14.10	358	6.77	172	0.52	13.2	0.31	7.9
14" x 8"	355.6 x 203.2	64.0	43	13.66	347	8.00	203	0.53	13.5	0.31	7.9
		71.4	48	13.79	350	8.03	204	0.60	15.2	0.34	8.6
		78.9	53	13.92	354	8.06	205	0.66	16.8	0.37	9.4
14" x 10"	355.6 x 254.0	90.8	61	13.89	353	10.00	254	0.65	16.5	0.38	9.7
		101.2	68	14.04	357	10.04	255	0.72	18.3	0.42	10.7
		110.1	74	14.17	360	10.07	256	0.79	20.1	0.45	11.4
		122.0	82	14.31	363	10.13	257	0.86	21.8	0.51	13.0
14" x 14 1/2"	355.6 x 368.3	133.9	90	14.02	356	14.52	369	0.71	18.0	0.44	11.2
		147.3	99	14.16	360	14.57	370	0.78	19.8	0.49	12.4
		162.2	109	14.32	364	14.61	371	0.86	21.8	0.53	13.5
		178.6	120	14.48	368	14.67	373	0.94	23.9	0.59	15.0
		196.4	132	14.66	372	14.73	374	1.03	26.2	0.65	16.5

VIGAS

Este producto cumple con los siguientes grados de acero A36 / A572°50 / A992

Dimensiones		Peso		Peralte		Ancho del patín		Espesor del patín		Espesor del alma	
Pulgadas	mm	kg/m	LB/FT	Pulgada	mm	Pulgada	mm	Pulgada	mm	Pulgada	mm
14" x 16"	355.6 x 406.4	215.8	145	14.78	375	15.50	394	1.09	27.7	0.68	17.3
		236.6	159	14.98	380	15.57	395	1.19	30.2	0.75	19.0
		261.9	176	15.22	387	15.65	398	1.31	33.3	0.83	21.1
		287.2	193	15.48	393	15.71	399	1.44	36.6	0.89	22.6
		314.0	211	15.72	399	15.80	401	1.56	39.6	0.98	24.9
		346.7	233	16.04	407	15.89	404	1.72	43.7	1.07	27.2
		382.4	257	16.38	416	15.99	406	1.89	48.0	1.17	29.7
		421.1	283	16.74	425	16.11	409	2.07	52.6	1.29	32.8
462.8	311	17.12	434	16.23	412	2.26	57.4	1.41	35.8		
16" x 5 1/2"	406.4 x 139.7	38.7	26	15.69	399	5.50	140	0.35	8.9	0.25	6.3
		46.1	31	15.88	403	5.53	140	0.44	11.2	0.28	7.1
16" x 7"	406.4 x 177.8	53.6	36	15.86	403	6.99	178	0.43	10.9	0.30	7.6
		59.5	40	16.01	407	7.00	178	0.51	13.0	0.31	7.9
		67.0	45	16.13	410	7.04	179	0.57	14.5	0.35	8.9
		74.4	50	16.26	413	7.07	180	0.63	16.0	0.38	9.7
		84.8	57	16.43	417	7.12	181	0.72	18.3	0.43	10.9
16" x 10 1/4"	406.4 x 260.3	99.7	67	16.33	415	10.24	260	0.67	17.0	0.40	10.2
		114.6	77	16.52	420	10.30	262	0.76	19.3	0.46	11.7
		132.6	89	16.75	425	10.37	263	0.88	22.2	0.53	13.3
		149.0	100	16.97	431	10.43	265	0.99	25.0	0.59	14.9
18" x 6"	457.2 x 152.4	52.1	35	17.70	450	6.00	152	0.43	10.9	0.30	7.6
		59.5	40	17.90	455	6.02	153	0.53	13.5	0.32	8.1
		68.4	46	18.06	459	6.06	154	0.61	15.5	0.36	9.1
18" x 7 1/2"	457.2 x 190.5	74.4	50	17.99	457	7.50	190	0.57	14.5	0.36	9.1
		81.8	55	18.11	460	7.53	191	0.63	16.0	0.39	9.9
		89.3	60	18.24	463	7.56	192	0.70	17.8	0.42	10.7
		96.7	65	18.35	466	7.59	193	0.75	19.0	0.45	11.4
		105.6	71	18.47	469	7.64	194	0.81	20.6	0.50	12.7
18" x 11"	457.2 x 279.4	113.1	76	18.21	463	11.04	280	0.68	17.3	0.43	10.9
		128.0	86	18.39	467	11.09	282	0.77	19.6	0.48	12.2
		144.3	97	18.59	472	11.15	283	0.87	22.1	0.54	13.7
		157.7	106	18.73	476	11.20	284	0.94	23.9	0.59	15.0
		177.1	119	18.97	482	11.27	286	1.06	26.9	0.66	16.8

VIGAS

Este producto cumple con los siguientes grados de acero A36 / A572°50 / A992

Dimensiones		Peso		Peralte A		Ancho del patín B		Espesor del patín		Espesor del alma C	
Pulgadas	mm	kg/m	LB/FT	Pulgada	mm	Pulgada	mm	Pulgada	mm	Pulgada	mm
18" x 11"	457.2 x 279.4	193.5	130	19.25	489	11.16	284	1.20	30.5	0.67	17.0
		212.8	143	19.49	495	11.22	285	1.32	33.5	0.73	18.5
		235.1	158	19.72	501	11.30	287	1.44	36.6	0.81	20.6
		260.0	175	20.04	509	11.38	289	1.59	40.4	0.90	22.6
21" x 6 1/2"	533.4 x 165.1	65.5	44	20.66	525	6.50	165	0.45	11.4	0.35	8.9
		74.4	50	20.83	529	6.53	166	0.54	13.7	0.38	9.7
		84.8	57	21.06	534	6.56	166	0.65	16.5	0.41	10.4
21" x 8 1/4"	533.4 x 209.5	71.5	48	20.63	524	8.15	207	0.43	10.9	0.35	9.0
		92.3	62	20.99	533	8.24	209	0.62	15.7	0.40	10.2
		101.2	68	21.13	537	8.27	210	0.69	17.5	0.43	10.9
		108.7	73	21.24	539	8.30	211	0.74	18.8	0.46	11.6
		123.5	83	21.43	544	8.36	212	0.84	21.3	0.52	13.2
		138.4	93	21.62	549	8.42	214	0.93	23.6	0.58	14.7
21" x 12 1/4"	533.4 x 311.1	150.3	101	21.36	543	12.29	312	0.80	20.3	0.50	12.7
		165.2	111	21.51	546	12.34	313	0.88	22.4	0.55	14.0
		181.5	122	21.68	551	12.39	315	0.96	24.4	0.60	15.2
		196.7	132	21.83	554	12.44	316	1.04	26.3	0.65	16.5
		218.7	147	22.06	560	12.51	318	1.15	29.2	0.72	18.3
*24" x 7"	609.6 x 177.8	81.8	55	23.57	599	7.01	178	0.51	13.0	0.40	10.2
		92.3	62	23.74	603	7.04	179	0.59	15.0	0.43	10.9
*24" x 9"	609.6 x 228.6	101.2	68	23.73	603	8.97	228	0.59	15.0	0.42	10.7
		113.1	76	23.92	608	8.99	228	0.68	17.3	0.44	11.2
		125.0	84	24.10	612	9.02	229	0.77	19.6	0.47	11.9
		139.9	94	24.31	617	9.07	230	0.88	22.4	0.52	13.2
		153.3	103	24.53	623	9.00	229	0.98	24.9	0.55	14.0
*24" x 12 3/4"	609.6 x 323.8	154.8	104	24.06	611	12.75	324	0.75	19.0	0.50	12.7
		174.1	117	24.26	616	12.80	325	0.85	21.6	0.55	14.0
		194.9	131	24.48	622	12.86	327	0.96	24.4	0.61	15.5
		217.3	146	24.74	628	12.90	328	1.09	27.7	0.65	16.5
		241.0	162	25.00	635	12.95	328	1.22	31.0	0.70	17.8
		261.9	176	25.24	641	12.89	327	1.34	34.0	0.75	19.1
		285.0	192	25.47	647	12.95	329	1.46	37.1	0.81	20.6
		306.0	207	25.70	653	13.00	330	1.57	39.9	0.87	22.1

VIGAS

Este producto cumple con los siguientes grados de acero A36 / A572^o50 / A992

Dimensiones		Peso		Peralte		Ancho del patín		Espesor del patín		Espesor del alma	
Pulgadas	mm	kg/m	LB/FT	Pulgada	mm	Pulgada	mm	Pulgada	mm	Pulgada	mm
*27" x 10"	685.8 x 254.0	125.0	84	26.71	678	9.96	253	0.64	16.3	0.46	11.7
		139.9	94	26.92	684	9.99	254	0.75	19.0	0.49	12.4
		151.8	102	27.09	688	10.02	255	0.83	21.1	0.52	13.2
		169.6	114	27.29	693	10.07	256	0.93	23.6	0.57	14.5
		192.0	129	27.63	702	10.01	254	1.10	27.9	0.61	15.5
*27" x 14"	685.8 x 355.6	217.3	146	27.38	695	13.97	355	0.98	24.9	0.61	15.5
		239.6	161	27.59	701	14.02	356	1.08	27.4	0.66	16.8
		265.0	178	27.79	706	14.09	358	1.19	30.2	0.72	18.4
		289.0	194	28.11	714	14.01	356	1.34	34.0	0.75	19.0
*30" x 10 1/2"	762.0 x 266.7	133.9	90	29.53	750	10.40	264	0.61	15.5	0.47	11.9
		147.3	99	29.65	753	10.45	265	0.67	17.0	0.52	13.2
		160.7	108	29.83	758	10.48	266	0.76	19.3	0.55	14.0
		172.6	116	30.01	762	10.50	267	0.85	21.6	0.57	14.5
		184.7	124	30.17	766	10.52	267	0.93	23.6	0.59	14.9
		196.4	132	30.31	769	10.54	267	1.00	25.4	0.61	15.5
		220.2	148	30.67	779	10.48	266	1.18	30.0	0.65	16.5
*30" x 15"	762.0 x 381.0	257.5	173	30.43	773	15.00	381	1.07	27.1	0.66	16.7
		284.2	191	30.66	779	15.04	382	1.19	30.1	0.71	18.0
		314.0	211	30.94	786	15.12	384	1.31	33.4	0.78	19.7
*33" x 11 1/2"	838.2 x 292.1	175.6	118	32.86	835	11.48	292	0.74	18.8	0.55	14.0
		193.4	130	33.09	840	11.51	292	0.86	21.8	0.58	14.7
		209.8	141	33.30	846	11.54	293	0.96	24.4	0.61	15.5
		226.2	152	33.49	850	11.56	293	1.05	26.7	0.63	16.0
*33" x 15 3/4"	838.2 x 400.1	299.0	201	33.70	856	15.71	399	1.15	29.2	0.72	18.2
		329.0	221	33.90	861	15.79	401	1.28	32.5	0.77	19.7
*36" x 12"	914.4 x 304.8	200.9	135	35.55	903	11.95	304	0.79	20.1	0.60	15.2
		223.2	150	35.85	911	11.98	304	0.94	23.9	0.63	16.0
		238.1	160	36.01	915	12.00	305	1.02	25.9	0.65	16.5
		253.3	170	36.17	918	12.03	306	1.10	27.9	0.68	17.2
		312.5	210	36.69	932	12.18	309	1.36	34.5	0.83	21.1
*36" x 16 1/2"	914.4 x 419.1	343.8	231	36.50	927	16.46	418	1.26	32.0	0.76	19.3
*40" x 12"	1016 x 304.8	221.7	149	38.20	970	11.81	300	0.83	21.1	0.63	16.0

NOTA: Vigas no incluidas en esta tabla, favor de solicitar más información
Dimensiones no incluidas

ÁNGULOS

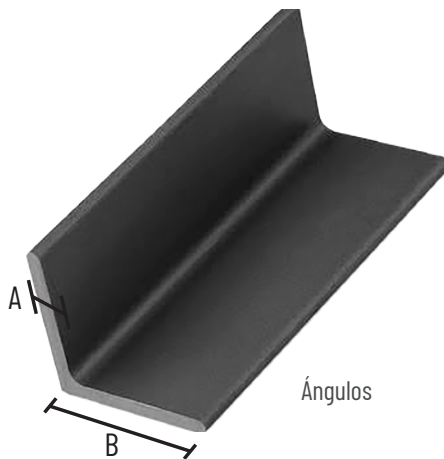

Ángulos a 6.10 mts (20 pies)

Ángulos a 6.10 mts (20 pies)

Espesor A	Ancho B	Espesor A	Ancho B	Peso	Espesor A	Ancho B	Espesor A	Ancho B	Peso	
Pulgadas		mm		Kg/m	Pulgadas		mm		Kg/m	
.109	x1	2.8	x 25.4	1.05	1/4	x1	6.3	x 25.4	2.22	
	x1 1/4		x 31.7	1.33		x 1 1/4		x 31.7	2.86	
	x1 1/2		x 38.1	1.61		x 1 1/2		x 38.1	3.48	
1/8	x 3/4	3.2	x 19.0	0.88	x 2	x 50.8	x 2 1/2	x 63.5	6.10	
	x 1		x 25.4	1.19		x 3		x 76.2	7.29	
	x 1 1/4		x 31.7	1.50		x 4		x 101.6	9.82	
	x 1 1/2		x 38.1	1.83				5/16	x 76.2	9.08
	x 2		x 50.8	2.46					x 101.6	12.20
3/16	x 1	4.8	x 25.4	1.73	3/8	x 50.8	9.5	x 63.5	8.78	
	x 1 1/4		x 31.7	2.20		x 76.2		10.71		
	x 1 1/2		x 38.1	2.68		x 101.6		14.58		
	x 1 3/4		x 44.4	3.15	x 5	x 127.0	18.30			
	x 2		x 50.8	3.63		x 6	x 152.4	22.17		
	x 2 1/2		x 63.5	4.57			1/2	x 76.2	13.99	
	x 3		x 76.2	5.52		x 101.6		19.05		
					x 152.4	29.16				

• Se manejan en acero A-36 o A-50

SOLERAS

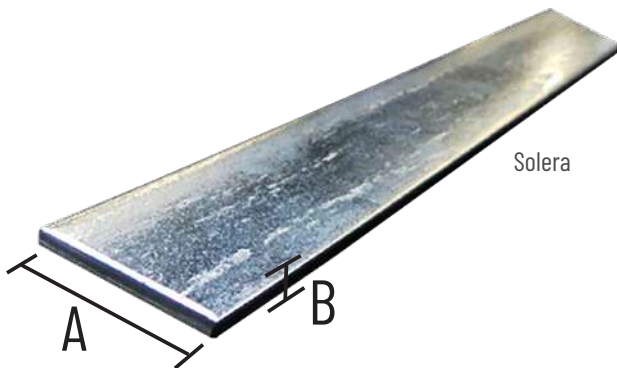

Soleras a 6.10 mts. (20 pies)

Pulgada		mm		Kg/m
A	B	A	B	
1/8	x 1/2	3.2	x 12.7	0.32
	x 3/4		x 19.0	0.47
	x 1		x 25.4	0.63
	x 1 1/4		x 31.7	0.79
	x 1 1/2		x 38.1	0.95
	x 2		x 50.8	1.27
	x 2 1/2		x 63.5	1.58
	x 3		x 76.2	1.90
	x 4		x 101.6	2.54
	3/16		x 1/2	4.8
x 3/4		x 19.0	0.71	
x 1		x 25.4	0.95	
x 1 1/4		x 31.7	1.19	
x 1 1/2		x 38.1	1.42	
x 2		x 50.8	1.90	
x 2 1/2		x 63.5	2.38	
x 3		x 76.2	2.84	
x 4		x 101.6	3.80	
x 6		x 152.4	5.68	
x 8	x 203.2	7.60		

Soleras a 6.10 mts. (20 pies)

Pulgadas		mm		Kg/m
1/4	x 1	6.3	x 25.4	
	x 1 1/4		x 31.7	1.58
	x 1 1/2		x 38.1	1.90
	x 2		x 50.8	2.53
	x 2 1/2		x 63.5	3.17
	x 3		x 76.2	3.79
	x 4		x 101.6	5.06
	x 5		x 127.0	6.32
	x 6		x 152.4	7.59
	x 8		x 203.2	10.13
	x 10		x 254.0	12.66
	x 12		x 304.8	15.18
3/8	x 1	9.5	x 25.4	1.90
	x 1 1/4		x 31.7	2.38
	x 1 1/2		x 38.1	2.84
	x 2		x 50.8	3.79
	x 2 1/2		x 63.5	4.75
	x 3		x 76.2	5.70
	x 4		x 101.6	7.59
	x 5		x 127.0	9.49
	x 6		x 152.4	11.40
	x 8		x 203.2	15.18
	x 10*		x 254.0	18.99
	x 12*		x 304.8	22.80

- Se manejan en acero A-36
- » Pregunte por soleras de slitter y de molino

SOLERAS

Soleras a 6.10 mts. (20 pies)

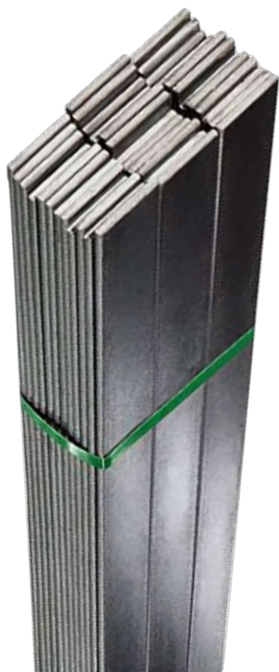

Soleras

Pulgadas		mm		Kg/m
1/2	x 1	12.7	x 25.4	2.53
	x 1 1/2		x 38.1	3.79
	x 2		x 50.8	5.06
	x 2 1/2		x 63.5	6.32
	x 3		x 76.2	7.59
	x 4		x 101.6	10.13
	x 5		x 127.0	12.66
	x 6		x 152.4	15.18
	x 8		x 203.2	20.24
	x 10		x 254.0	25.33
	x 12		x 304.8	30.36
*5/8	x 3	15.9	x 76.2	9.49
	x 4		x 101.6	12.66
	x 5		x 127.0	15.83
	x 6		x 152.4	18.99
	x 8		x 203.2	25.33
	x 10		x 254.0	31.66
	x 12		x 304.8	37.97
*3/4	x 1 1/2	19.0	x 38.1	5.70
	x 2		x 50.8	7.59
	x 2 1/2		x 63.5	9.49
	x 3		x 76.2	11.40
	x 4		x 101.6	15.18
	x 5		x 127.0	18.99
	x 6		x 152.4	22.80
	x 8		x 203.2	30.36
	x 10		x 254.0	37.97
	x 12		x 304.8	45.59
*1	x 2	25.4	x 50.8	10.13
	x 3		x 76.2	15.18
	x 4		x 101.6	20.27
	x 6		x 152.4	30.36
	x 8		x 203.2	40.53
	x 10		x 254.0	50.65
	x 12		x 304.8	60.71

- Se manejan en acero A-36
- » Pregunte por soleras de slitter y de molino

VARILLA CUADRADA O REDONDA

Varillas redondas y cuadradas se manejan 6.10 mts (20 pies)

Pulgada	mm	Redondos (Kg/m)	Cuadrados (Kg/m)
★3/8	9.5	0.56	0.71
★12 mm	12.0	---	1.20
★1/2	12.7	0.99	1.27
★5/8	15.9	1.55	1.98
3/4	19.0	2.24	2.85
7/8	22.2	3.04	---
1	25.4	3.98	5.06
*1 1/8	28.6	5.03	---
1 1/4	31.7	6.21	---
1 1/2	38.1	8.95	11.39
*1 3/4	44.4	12.18	---
2	50.8	15.91	20.25
*2 1/2	63.5	24.85	---

★También se manejan retorcidos

• Se manejan en acero A-36

* Sobre pedido

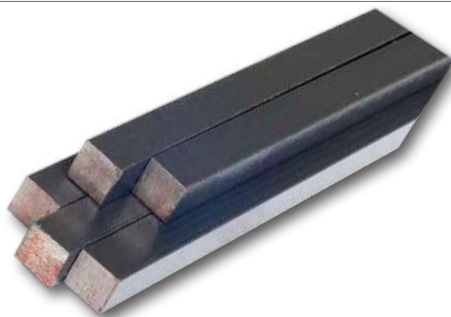

Varilla cuadrada se maneja 6.10 mts (20 pies)



Varilla redonda se maneja 6.10 mts (20 pies)

Varilla Pulida o Semiflecha



Varillas pulida o semiflecha se manejan A-36

Pulgadas	mm	Kg/m
3/16	4.8	0.14
1/4	6.3	0.25
5/16	7.9	0.39
3/8	9.53	0.56

HSS

Perfiles HSS se manejan en largos de 12.20 mts

Dimensiones Exteriores		Espesor		Peso	
Pulgada (AxB)	mm	Pulgada	mm	kg/pza	kg/m
4" x 4"	102 x 102	0.312	7.9	270	22.13
		0.375	9.5	314	25.73
5" x 5"	127 x 127	0.312	7.9	348	28.52
		0.375	9.5	408	33.44
6" x 4"	152 x 102	0.312	7.9	348	28.52
		0.375	9.5	408	33.44
6" x 6"	152 x 152	0.187	4.7	264	21.63
		0.250	6.3	346	28.36
		0.312	7.9	424	34.75
		0.375	9.5	500	40.98
		0.500	12.7	640	52.45
8" x 3"	203 x 76	0.125	3.2	166	13.61
		0.187	4.7	244	20.00
8" x 4"	203 x 102	0.187	4.7	264	21.63
		0.250	6.3	346	28.36
		0.312	7.9	424	34.75
		0.375	9.5	500	40.98
		0.500	12.7	640	52.45
8" x 6"	203 x 152	0.250	6.3	408	33.44
		0.375	9.5	592	48.52
8" x 8"	203 x 203	0.187	4.7	358	29.34
		0.250	6.3	470	38.52
		0.312	7.9	580	47.54
		0.375	9.5	686	56.23
		0.500	12.7	888	72.78
10" x 6"	254 x 152	0.187	4.7	358	29.34
		0.250	6.4	470	38.52
		0.375	9.5	686	56.23
		0.375	9.5	686	56.23
		0.500	12.7	888	72.78

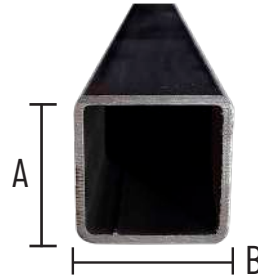

Perfiles HSS se manejan en largos de 12.20 mts

Dimensiones Exteriores		Espesor		Peso	
Pulgada (AxB)	mm	Pulgada	mm	kg/pza	kg/m
10" x 10"	254 x 254	0.187	4.7	450	36.88
		0.250	6.3	594	48.69
		0.312	7.9	734	60.16
		0.375	9.5	870	71.31
		0.500	12.7	1,134	92.96
12" x 6"	305 x 152	0.375	9.5	778	63.77
12" x 8"	305 x 203	0.250	6.3	594	48.69
		0.375	9.5	870	71.31
		0.500	12.7	1,134	92.96
12" x 12"	305 x 305	0.250	6.3	716	58.68
		0.312	7.9	888	72.79
		0.375	9.5	1,056	86.55
		0.500	12.7	1,382	113.27
		0.625	15.9	1,696	139.02
14" x 14"	356 x 356	0.312	7.9	1,042	85.40
		0.375	9.5	1,242	101.80
		0.500	12.7	1,630	133.61
		0.625	15.9	2,004	164.26
16" x 16"	406 x 406	0.312	7.9	1,196	98.03
		0.375	9.5	1,426	116.89
		0.500	12.7	1,876	153.77
		0.625	15.9	2,314	189.67

» Otras medidas sobre pedido

POLÍN

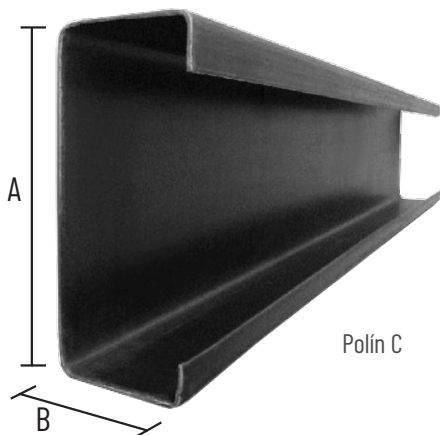

Perfil	Peralte		Calibre	Longitud estándar en mts	Tipo de lámina		kg por mts	kg por pieza
	mm	pulg			A.R.	C.C.		
3 EP 14	76	3	14	6		x	2.4	14.4
4 EP 14	102	4	14	4	x	x	3.5	14.0
4 EP 14	102	4	14	5		x	3.5	17.5
4 EP 14	102	4	14	6		x	3.5	21.0
5 EP 14	127	5	14	5	x	x	3.8	19.0
5 EP 14	127	5	14	6		x	3.8	22.8
6 EP 12	152	6	12	6	x		5.8	34.8
6 EP 14	152	6	14	6	x	x	4.2	25.2
8 EP 10	203	8	10	8	x		9.8	78.4
8 EP 12	203	8	12	8	x		7.7	61.6
8 EP 14	203	8	14	8	x	x	5.6	44.8
10 EP 10	254	10	10	10	x		11.2	112.0
10 EP 12	254	10	12	10	x		8.8	88.0
10 EP 14	254	10	14	10	x	x	6.4	64.0
12 EP 10	305	12	10	12	x		14.4	172.8
12 EP 12	305	12	12	12	x		11.1	133.2
12 EP 14	305	12	14	12	x		8.0	96.0

PTR



Dimensiones				Espesor		Peso		
Pulgada		mm		Color	Pulg.	mm	kg/m	lbs/P
A	B	A	B					
1" X 1"		25 X 25		Green	0.095	2.4	1.62	1.09
				Red	0.133	3.4	2.10	1.41
1-1/2" x 1-1/2"		38 X 38		White	0.110	2.8	2.95	2.69
				Green	0.125	3.2	3.29	2.18
				Red	0.154	4.0	3.91	2.62
2" x 2"		51 X 51		White	0.110	2.8	4.00	2.69
				Green	0.125	3.2	4.54	3.05
				Red	0.156	4.0	5.45	3.66
2-1/2" x 2-1/2"		64 X 64		White	0.125	3.2	5.84	3.92
				Green	0.141	3.6	6.47	4.35
				Red	0.188	4.8	8.32	5.59
3" x 3"		76 X 76		White	0.125	3.2	7.12	4.78
				Green	0.156	4.0	8.62	5.79
				Red	0.188	4.8	10.20	6.85
3-1/2" x 3-1/2"		89 X 89		White	0.125	3.2	8.39	5.63
				Green	0.156	4.0	10.20	6.85
				Red	0.188	4.8	12.10	8.13
				Blue	0.250	6.4	15.60	10.48
3" x 2"		76 X 51		White	0.125	3.2	5.84	3.92
				Green	0.141	3.6	6.47	4.35
				Red	0.188	4.8	8.32	5.59
4" x 2"		102 X 51		White	0.125	3.2	7.12	4.78
				Green	0.156	4.0	8.62	5.79
				Red	0.188	4.8	10.20	6.85
4" x 3"		102 X 76		White	0.125	3.2	8.39	5.63
				Green	0.156	4.0	10.20	6.85
				Red	0.188	4.8	12.10	8.13
				Blue	0.250	6.4	15.60	10.48

PERFILES LAMINADOS

Perfiles - Ventana

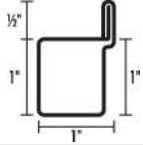
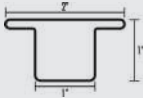
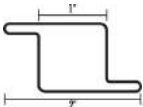
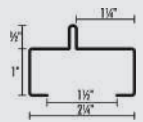
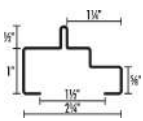
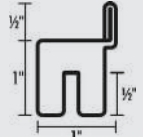
Figura / Descripción	Calibre (nominal)	Espesor (pulgada)	Longitud (m)	Pza por paquete	kg x m	
	101	20	0.0359	6.00	100	0.91
		18	0.0478	6.00	100	1.22
	103	20	0.0359	6.00	80	1.08
		18	0.0478	6.00	80	1.47
	106	20	0.0359	6.00	80	1.08
		18	0.0478	6.00	80	1.47
	121	20	0.0359	6.00	96	1.00
		18	0.0478	6.00	96	1.36
	122	20	0.0359	6.00	80	1.00
		18	0.0458	6.00	80	1.36
	123	20	0.0359	6.00	80	1.07

- » Producto especial sobre pedido
- » Pintado en rojo

PERFILES LAMINADOS

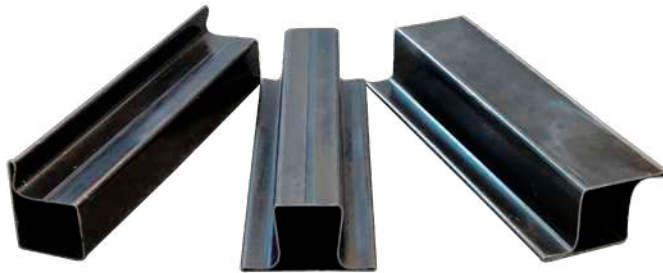

Perfiles - Ventana

Perfiles - Ventana

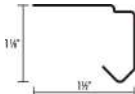
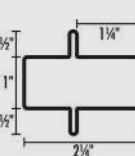
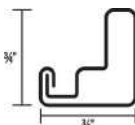
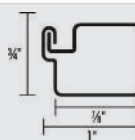
Figura / Descripción	Calibre (nominal)	Espesor (pulgada)	Longitud (m)	Pza por paquete	kg x m	
	124	18	0.0478	6.00	100	0.68
	127	20	0.0359	6.00	60	1.41
		18	0.0478	6.00	60	1.91
	131	20	0.0359	6.00	160	0.64
	145	20	0.0359	6.00	160	0.64
	159	20	0.0359	6.00	54	1.33
		18	0.0478	6.00	54	1.81

PERFILES LAMINADOS

Perfiles -Puertas

Figura / Descripción	Calibre (nominal)	Espesor (pulgada)	Longitud (m)	Pza por paquete	kg x m	
	126	20	0.0359	6.00	48	1.27
	18	0.0478	6.00	48	1.72	
	P-100	20	0.0359	6.00	96	1.01
	18	0.0478	6.00	96	1.36	
	P-150	20	0.0359	6.00	70	1.19
	18	0.0478	6.00	70	1.61	
	P-200	20	0.0359	6.00	72	1.37
	18	0.0478	6.00	72	1.86	
	P-250	20	0.0359	6.00	42	1.56
	18	0.0478	6.00	42	2.09	
	P-300	20	0.0359	6.00	54	1.73
	18	0.0478	6.00	54	2.32	
	P-400	20	0.359	6.00	48	2.09
	18	0.478	6.00	48	2.82	

PERFILES LAMINADOS

Perfiles -Puertas

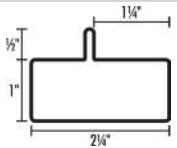
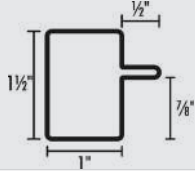
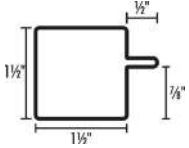
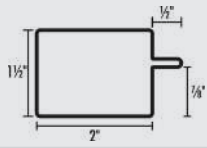
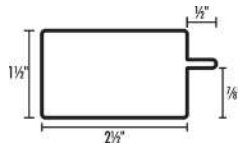
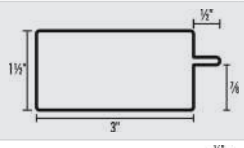
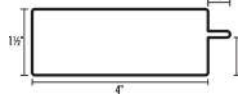
Figura / Descripción	Calibre (nominal)	Espesor (pulgada)	Longitud (m)	Pza por paquete	kg x m	
	126	20	0.0359	6.00	48	1.27
		18	0.0478	6.00	48	1.72
	P-100	20	0.0359	6.00	96	1.01
		18	0.0478	6.00	96	1.36
	P-150	20	0.0359	6.00	70	1.19
		18	0.0478	6.00	70	1.61
	P-200	20	0.0359	6.00	72	1.37
		18	0.0478	6.00	72	1.86
	P-250	20	0.0359	6.00	42	1.56
		18	0.0478	6.00	42	2.09
	P-300	20	0.0359	6.00	54	1.73
		18	0.0478	6.00	54	2.32
	P-400	20	0.359	6.00	48	2.09
		18	0.478	6.00	48	2.82

PERFILES LAMINADOS



Perfiles - Puertas

- N - Natural
- PR - Pintado Rojo
- *GV - Galvanizado Verde
- *GN - Galvanizado Natural
- *Fabricación Especial

Perfiles - Puertas

Figura / Descripción	Calibre (nominal)	Espesor (pulgada)	Longitud (m)	Pza por paquete	kg x m
	20	0.0359	6.00	96	1.16
	18	0.0478	6.00	96	1.58
	20	0.0359	6.00	54	1.34
	18	0.0478	6.00	54	1.83
	20	0.0359	6.00	48	1.52
	20	0.0359	6.00	45	1.88
	18	0.0478	6.00	45	2.57

PERFILES LAMINADOS

Perfiles -Puertas

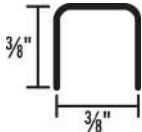
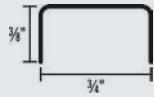
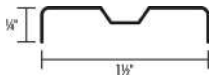
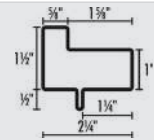
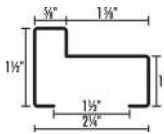
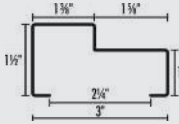
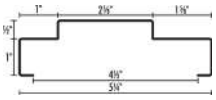
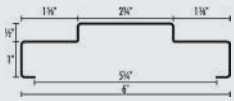
Figura / Descripción	Calibre (nominal)	Espesor (pulgada)	Longitud (m)	Pza por paquete	kg x m	
	154	20	0.0359	6.00	450	0.18
		18	0.0478	6.00	450	0.25
	155	20	0.0359	6.00	300	0.23
	156	20	0.0359	6.00	250	0.39
	M-221	20	0.0359	6.00	72	1.46
	M-225	20	0.0359	5.50	96	1.03
		18	0.0478	5.50	96	1.41
	M-300	20	0.0359	5.50	96	1.17
	M-525	20	0.359	5.50	42	1.56
		18	0.478	5.50	42	2.12
	M-600	20	0.0359	5.50	42	1.69
		18	0.0478	6.00	42	2.31

- » Producto especial sobre pedido
- » Pintado en rojo

PERFILES LAMINADOS



Perfiles - Puertas

Perfiles -Puertas

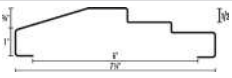
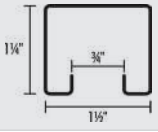
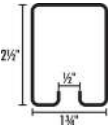
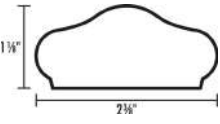
Figura / Descripción	Calibre (nominal)	Espesor (pulgada)	Longitud (m)	Pza por paquete	kg x m	
	M-725	18	0.0478	5.50	54	2.68
	1400	18	0.0478	6.00	72	1.24
	1500	16	0.0598	6.00	30	2.45
		14	0.0747	6.00	32	3.06
	160	20	0.0359	6.00	90	1.08
		18	0.0478	6.00	90	1.47

PTR/PERFIL RECTANGULAR

PTR						
Descripción	Dimensión (pulgada)	Calibre (nominal)	Espesor (pulgada)	Longitud (m)	Piezas x paquete	kg x m
R-100	1.00 x 0.50"	20	0.0359	6.00	120	0.52
		18	0.0478	6.00	120	0.68
		16	0.0598	6.00	120	0.84
		14	0.0747	6.00	120	1.02
R-125	1.25 x 0.75"	20	0.0359	6.00	99	0.70
		18	0.0478	6.00	99	0.92
		16	0.0598	6.00	99	1.14
		14	0.0747	6.00	99	1.40
R-155	1.50 x 0.50"	20	0.0359	6.03	98	0.70
		18	0.0478	6.03	98	0.92
		14	0.0747	6.00	98	1.40
R-150	1.50 x 0.75"	16	0.0598	6.00	98	1.29
		14	0.0747	6.00	98	1.59
		11	0.1196	6.00	98	2.25
R-151	1.50 x 1.00"	20	0.0359	6.00	84	0.88
		18	0.0478	6.00	84	1.16
		16	0.0598	6.00	100	1.44
		14	0.0747	6.00	84	1.78
		11	0.1196	6.00	63	2.55
R-175	1.75 x 0.75"	20	0.0359	6.00	84	0.88
		18	0.0478	6.00	84	1.16
R-200	2.00 x 1.00"	20	0.0359	6.00	50	1.06
		18	0.0478	6.00	50	1.40
		16	0.0598	6.00	50	1.74
		14	0.0747	6.00	50	2.15
		12	0.1046	6.00	50	2.95
		11	0.1196	6.00	50	3.15

PTR/PERFIL RECTANGULAR



• Para factibilidad en diferentes calibres, longitudes y acabados pregunte a su asesor de ventas.

PTR/Perfil Rectangular

Descripción	Dimensión (pulgada)	Calibre (nominal)	Espesor (pulgada)	Longitud (m)	Piezas x paquete	kg x m
R-225	2.25 x 0.75"	20	0.0359	6.00	55	1.06
		18	0.0478	6.00	55	1.40
		20	0.0359	6.00	54	1.34
		18	0.0478	6.00	54	1.77
R-249	2.50 x 1.25"	16	0.0598	6.00	54	2.20
		14	0.0747	6.00	54	2.72
		12	0.1046	6.00	54	3.75
R-250	2.50 x 1.50"	18	0.0478	6.00	48	1.89
		14	0.0747	6.00	48	2.91
		12	0.1046	6.00	40	4.01
		11	0.1196	6.00	40	4.36
R-275	2.75 x 1.00"	12	0.1046	6.00	40	3.75
		11	0.1196	6.00	40	4.06
R-375	3.00 x 0.75"	14	0.0747	6.00	48	2.72
		18	0.0478	6.00	48	1.89
		16	0.0598	6.00	48	2.35
R-301	3.00 x 1.00"	14	0.0747	6.00	48	2.91
		11	0.1196	6.00	48	4.36
		10	0.1345	6.00	48	4.84
		22	0.0299	6.00	49	1.34

PTR/PERFIL RECTANGULAR

PTR						
Descripción	Dimensión (pulgada)	Calibre (nominal)	Espesor (pulgada)	Longitud (m)	Piezas x paquete	kg x m
R-300	3.00 x 1.50"	20	0.0359	6.00	49	1.61
		18	0.0478	6.00	49	2.13
		16	0.0598	6.00	49	2.65
		14	0.0747	6.00	49	3.29
R-302	3.00 x 2.00"	16	0.0598	6.00	28	2.95
		14	0.0747	6.00	35	3.67
		12	0.1046	6.00	28	5.07
		11	0.1196	6.00	28	5.57
		10	0.1345	6.00	28	6.20
		9	0.1495	6.00	28	6.82
		3 / 16	0.1875	6.10	28	8.32
		1 / 4	0.2500	6.10	28	10.57
R-400	4.00 x 1.50"	20	0.0359	6.00	35	1.97
		18	0.0478	6.00	35	2.61
		16	0.0598	6.00	35	3.26
		14	0.0747	6.00	35	4.04
R-402	4.00 x 2.00"	14	0.0747	6.00	35	4.42
		11	0.1196	6.00	20	6.78
		10	0.1345	6.00	20	7.56
		9	0.1495	6.00	20	8.33
		3 / 16	0.1875	6.10	20	10.21
		1 / 4	0.2500	6.10	15	13.10
R-403	4.00 x 3.00"	14	0.0747	6.00	20	5.18
		11	0.1196	6.00	15	7.99
		9	0.1495	6.00	15	9.85
		3 / 16	0.1875	6.10	15	12.11
		1 / 4	0.2500	6.10	15	15.63

PTC/PERFIL RECTANGULAR



• Para factibilidad en diferentes calibres, longitudes y acabados pregunte a su asesor de ventas.

PTC/Perfil Rectangular

Descripción	Dimensión (pulgada)	Calibre (nominal)	Espesor (pulgada)	Longitud (m)	Piezas x paquete	kg x m
R-502	5.00 x 2.00"	11	0.1196	6.00	20	7.99
		3 / 16	0.1875	6.10	20	12.11
		1 / 4	0.2500	6.10	20	15.63
R-503	5.00 x 3.00"	11	0.1196	6.00	16	9.21
		10	0.1345	6.00	16	10.29
		3 / 16	0.1875	6.10	16	14.01
		1 / 4	0.2500	6.10	16	18.16
		14	0.0747	6.00	24	5.93
		11	0.1196	6.00	15	9.21
R-602	6.00 x 2.00"	3 / 16	0.1875	6.10	15	14.01
		1 / 4	0.2500	6.10	15	18.16
		11	0.1196	6.00	16	10.42
R-603	6.00 x 3.00"	3 / 16	0.1875	6.10	16	15.90
		1 / 4	0.2500	6.10	16	20.69
		11	0.1196	6.00	12	11.63
R-604	6.00 x 4.00"	9	0.1495	6.10	12	14.38
		3 / 16	0.1875	6.10	12	17.80
		1 / 4	0.2500	6.10	12	23.22
		3 / 16	0.1875	12.20	9	21.60
R-804	8.00 x 4.00"	1 / 4	0.2500	12.20	9	28.27

PTC/PERFIL TUBULAR CUADRADO

PTC

Descripción	Dimensión (pulgada)	Calibre (nominal)	Espesor (pulgada)	Longitud (m)	Piezas x paquete	kg x m
C-050	0.500"	22	0.0299	6.00	231	0.28
		20	0.0359	6.00	231	0.34
		18	0.0478	6.00	231	0.44
		16	0.0598	6.00	182	0.53
C-062	0.625"	20	0.0359	6.00	252	0.43
		18	0.0478	6.00	252	0.56
		16	0.0598	6.00	252	0.68
C-075	0.750"	22	0.0299	6.00	120	0.44
		20	0.0359	6.00	120	0.52
		18	0.0478	6.00	120	0.68
		16	0.0598	6.00	120	0.84
C-087	0.875"	14	0.0747	6.00	120	1.02
		20	0.0359	6.00	112	0.61
		14	0.0747	6.00	112	1.21
C-100	1.000"	20	0.0359	6.00	100	0.70
		18	0.0478	6.00	100	0.92
		16	0.0598	6.00	100	1.14
		14	0.0747	6.00	100	1.40
		13	0.0897	6.00	100	1.65
		12	0.1046	6.00	80	1.90
		11	0.1196	6.00	80	1.94
C-125	1.250"	10	0.1345	6.00	80	2.12
		20	0.0359	6.00	81	0.88
		18	0.0478	6.00	81	1.16
		16	0.0598	6.00	81	1.44
		14	0.0747	6.00	81	1.78
		12	0.1046	6.00	63	2.42
		11	0.1196	6.00	63	2.55
		10	0.1345	6.00	63	2.80

PTC/PERFIL CUADRADO

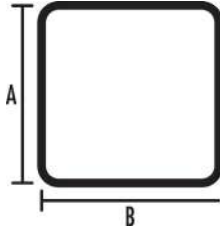

• Para factibilidad en diferentes calibres, longitudes y acabados pregunte a su asesor de ventas.

PTC/Perfil Cuadrado

Descripción	Dimensión (pulgada)	Calibre (nominal)	Espesor (pulgada)	Longitud (m)	Piezas x paquete	kg x m
C-150	1.500"	20	0.0359	6.00	49	1.06
		18	0.0478	6.00	49	1.40
		16	0.0598	6.00	49	1.74
		14	0.0747	6.00	49	2.15
		12	0.1046	6.00	49	2.95
		11	0.1196	6.00	49	3.15
		10	0.1345	6.00	49	3.48
		9	0.1495	6.00	49	3.79
C-175	1.750"	16	0.0598	6.00	60	2.05
		14	0.0747	6.00	60	2.53
		11	0.1196	6.00	60	3.76
C-200	2.000"	20	0.0359	6.00	50	1.43
		18	0.0478	6.00	50	1.89
		16	0.0598	6.00	50	2.35
		14	0.0747	6.00	50	2.91

PTC/PERFIL CUADRADO

PTC

Descripción	Dimensión (pulgada)	Calibre (nominal)	Espesor (pulgada)	Longitud (m)	Piezas x paquete	kg x m
C-200	2.000"	12	0.1046	6.00	40	4.01
		11	0.1196	6.00	40	4.36
		10	0.1345	6.00	40	4.84
		9	0.1495	6.10	40	5.31
		3 / 16	0.1875	6.10	40	6.42
		1 / 4	0.2500	6.10	40	8.04
C-225	2.250"	16	0.0598	6.00	50	2.65
		14	0.0747	6.00	50	3.29
		16	0.0598	6.00	36	2.95
		14	0.0747	6.00	36	3.67
		13	0.0897	6.00	36	4.38
C-250	2.500"	12	0.1046	6.00	27	5.07
		11	0.1196	6.00	27	5.57
		10	0.1345	6.00	27	6.20
		9	0.1495	6.00	27	6.82
		3 / 16	0.1875	6.10	27	8.32
C-300	3.000"	1 / 4	0.2500	6.10	27	10.57
		14	0.0747	6.00	35	4.42
		13	0.0897	6.00	35	5.28
		12	0.1046	6.00	21	6.13
		11	0.1196	6.00	21	6.78
		10	0.1345	6.00	21	7.56
		9	0.1495	6.00	21	8.33
		3 / 16	0.1875	6.10	21	10.21
C-350	3.500"	1 / 4	0.2500	6.10	21	13.10
		14	0.0747	6.00	18	5.18
		11	0.1196	6.00	18	7.99
		9	0.1495	6.00	18	9.85
		3 / 16	0.1875	6.10	18	12.11
		1 / 4	0.2500	6.10	18	15.63

PTC/PERFIL CUADRADO

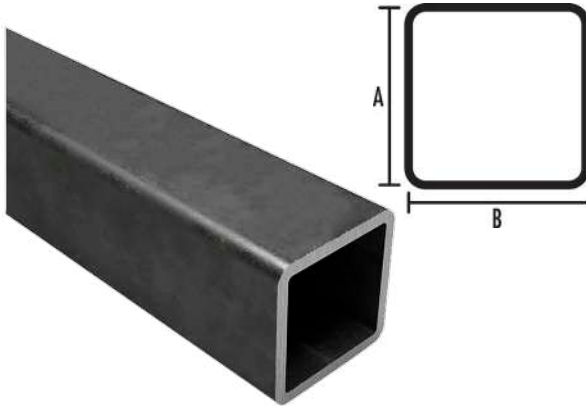

· Para factibilidad en diferentes calibres, longitudes y acabados pregunte a su asesor de ventas.

PTC/Perfil Cuadrado

Descripción	Dimensión (pulgada)	Calibre (nominal)	Espesor (pulgada)	Longitud (m)	Piezas x paquete	kg x m
· N - Natural C-400	4.000"	14	0.0747	6.00	20	5.93
		11	0.1196	6.00	15	9.21
		10	0.1345	6.00	15	10.29
		9	0.1495	6.00	15	11.36
		3 / 16	0.1875	6.10	15	14.01
C-450	4.500"	1 / 4	0.2500	6.10	15	18.16
		11	0.1196	6.00	12	10.42
		3 / 16	0.1875	6.10	12	15.90
C-500	5.000"	1 / 4	0.2500	6.10	12	20.69
		3 / 16	0.1875	6.10	12	17.80
C-600	6.000"	1 / 4	0.2500	6.10	12	23.22
		3 / 16	0.1875	12.20	9	21.60
		1 / 4	0.2500	12.20	9	28.27

TABLEROS

Descripción	Dimensión Nominal				Dimensión Efectiva			
	Ancho (pies)	Largo (pies)	Calibre (nominal)	Espesor (pulgadas)	Ancho (m)	Longitud (m)	Kg x m	
147-A	3'	6'	22	0.0299	0.92	1.76	5.45	
	3'	6.4'	20	0.0359	0.92	1.88	6.53	
	3'	8'	20	0.0359	0.92	2.35	6.53	
			22	0.0299	0.92	2.35	5.45	
	3'	10'	20	0.0359	0.92	2.95	6.53	
			22	0.0299	0.92	2.95	5.45	
	147-L	1.9'	10'	20	0.0359	0.56	3.05	4.09
		2'	10'	20	0.0359	0.59	3.05	4.36
		3'	3'	20	0.0359	0.89	0.91	6.53
		3'	6'	20	0.0359	0.89	1.83	6.53
3'		6.4'	20	0.0359	0.89	1.96	6.53	
3'		8'	20	0.0359	0.89	2.44	6.53	
3'		10'	20	0.0359	0.89	3.05	6.53	
147-LC	3'	3'	20	0.0359	0.89	0.91	6.53	
			22	0.0299	0.89	0.91	5.45	
	3'	6'	20	0.0359	0.89	1.83	6.53	
			22	0.0299	0.89	1.83	5.45	
	3'	8'	20	0.0359	0.89	2.44	6.53	
			22	0.0299	0.89	2.44	5.45	
	3'	10'	20	0.0359	0.89	3.05	6.53	
			22	0.0299	0.89	3.05	5.45	

TABLEROS

Descripción	Dimensión Nominal				Dimensión Efectiva		Kg x m
	Ancho (pies)	Largo (pies)	Calibre (nominal)	Espesor (pulgadas)	Ancho (m)	Largo (m)	
148-LC	3'	3'	22	0.0299	0.76	0.91	5.45
	3'	6'	22	0.0299	0.76	1.83	5.45
	3'	6.5'	22	0.0299	0.76	1.99	5.45
	3'	8'	22	0.0299	0.76	2.44	5.45
	3'	10'	22	0.0299	0.76	3.05	5.45
	4'	3'	22	0.0299	1.02	0.91	7.25
	4'	6'	22	0.0299	1.02	1.83	7.25
	4'	6.5'	22	0.0299	1.02	1.99	7.25
	4'	7'	22	0.0299	1.02	2.13	7.25
	4'	8'	20	0.0359	1.02	2.44	8.73
	4'		22	0.0299	1.02	2.44	7.25
	4'	10'	22	0.0299	1.02	3.05	7.25
149-A	3'	10'	20	0.0359	0.92	2.76	6.53
149-L	3'	3'	20	0.0359	0.81	0.91	6.53
	3'	6.4'	20	0.0359	0.81	1.96	6.53
	3'	8"	20	0.0359	0.81	2.44	6.53
	3'	10'	20	0.0359	0.81	3.05	6.53
	3'	10'	20	0.0359	0.81	3.05	6.53
149-LC	3'	3'	20	0.0359	0.81	0.91	6.53
	3'	6'	20	0.0359	0.81	1.83	6.53
	3'	6.4'	20	0.0359	0.81	1.96	6.53
	3'	8'	20	0.0359	0.81	2.44	6.53
	3'	10'	20	0.0359	0.81	3.05	6.53

• A - Moldura a lo Ancho • L - Moldura a lo Largo • LC - Moldura Largo Continuar

TABLEROS

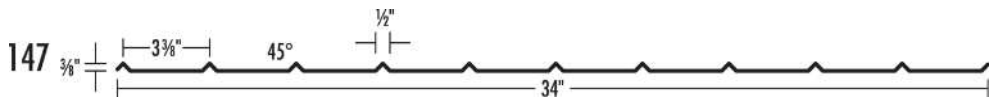
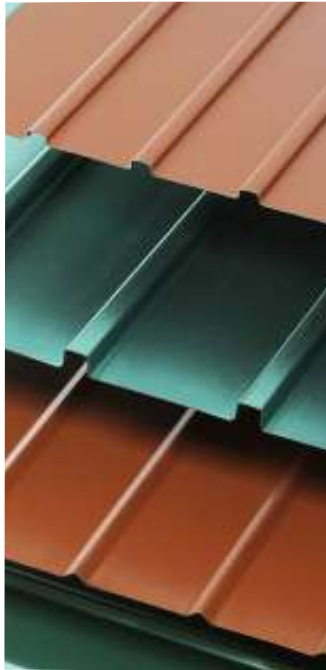

TUBERÍAS

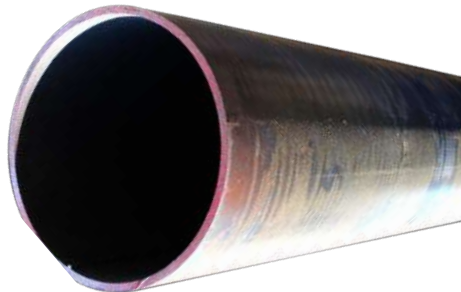
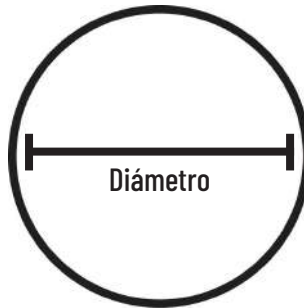

Cédula 30

Dia Nom. (in)	Dia Ext. (in)	Calibre (nominal)	Espesor (in)	Longitud (m)	Pzas x paquete	Kg x m
1/2"	0.840"	14	0.0747	6.10	169	0.91
3/4"	1.050"	14	0.0747	6.10	127	1.16
1"	1.315"	14	0.0747	6.10	91	1.47
1 1/4"	1.660"	13	0.0897	6.10	61	2.24
1 1/2"	1.900"	13	0.0897	6.10	61	2.58
2"	2 3/8"	12	0.1046	6.10	37	3.77
2 1/2"	2 7/8"	12	0.1046	6.10	37	4.61
3"	3 1/2"	11	0.1196	6.10	19	6.43
4"	4 1/2"	11	0.1196	6.10	19	8.33
5"	5 1/2"	-	-	-	-	-
6"	6 5/8"	3/16"	0.1875	6.10	7	19.18

TUBERÍAS



Cédula 40

Dia Nom. (pulgada)	Dia Ext. (pulgada)	Calibre (nominal)	Espesor (pulgadas)	Longitud (m)	Pzas x paquete	Kg x m
1/4"	0.540"	14	0.0747	6.40	169	0.55
3/8"	0.675"	13	0.897	6.40	169	0.83
1/2"	0.840"	12	0.1046	6.40	91	1.22
3/4"	1.050"	12	0.1046	6.40	91	1.57
1"	1.315"	10	0.1345	6.40	61	2.52
1 1/4"	1.660"	10	0.1345	6.40	37	3.26
1 1/2"	1.900"	10	0.1345	6.40	37	4.16
2"	2 3/8"	9	0.1495	6.00	37	5.29
2 1/2"	2 7/8"	0.203	0.2030	6.00 / 6.40	37	8.62
3"	3 1/2"	4	0.2242	6.00 / 6.40	19	11.67
4"	4 1/2"	4	0.2242	6.00 / 6.40	19	15.24
6"	6 5/8"	0.280	0.2800	6.00 / 6.40	7	28.24

Cédula 80

Calibre (nominal)	Espesor (pulgadas)	Longitud (m)	Pzas x paquete	Kg x m
0.216"	0.2160	6.40	37	7.41
1/4"	0.2500	6.40	37	10.43
5/16"	0.3125	6.40	19	15.83
5/16"	0.3125	6.40	19	20.80

• *Cotizar sobre pedido

TUBERÍAS

Tubería Negra Industrial

Descripción	Dim (in)	Calibre (in)	Espesor (in)	Longitud (m)	Pzas x paquete	Kg x m
1/2"	0.500"	22	0.0299	6.00	228	0.22
		20	0.0359	6.03	228	0.26
		18	0.0478	6.03	228	0.34
5/8"	0.625"	22	0.0299	6.03	216	0.28
		20	0.0359	6.03	216	0.34
		18	0.0478	6.03	228	0.44
3/4"	0.750"	14	0.0747	6.40	217	0.71
		22	0.0299	6.03	186	0.34
		20	0.0359	6.03	186	0.41
		18	0.0478	6.03	186	0.53
	16	0.0598	6.03	169	0.66	
7/8"	0.875"	13	0.0897	6.40	91	1.07
		20	0.0359	6.03	180	0.48
		18	0.0478	6.03	150	0.63
		14	0.0747	6.03	169	0.95
1"	1.000"	20	0.0359	6.03	137	0.55
		18	0.0478	6.03	137	0.72
		16	0.0598	6.03	127	0.89
	1.125"	18	0.0478	6.03	175	0.82
		14	0.0747	6.03	186	1.25
1 1/4"	1.250"	20	0.0359	6.03	124	0.69
		18	0.0478	6.03	124	0.91
		16	0.0598	6.03	127	1.13
		14	0.0747	6.03	127	1.40
		12	0.1046	6.03	61	2.01
1 1/2"	1.500"	20	0.0359	6.03	102	0.73
		18	0.0478	6.03	102	0.96
		16	0.0598	6.03	91	1.19
		12	0.1046	6.03	61	2.01
1 1/2"	1.500"	20	0.0359	6.03	95	0.84



TUBERÍAS

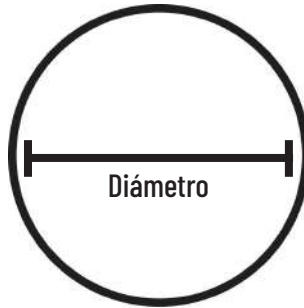

Tubería Redonda

Descripción	Dim (in)	Calibre (in)	Espesor (in)	Longitud (m)	Pzas x paquete	Kg x m
1 1/2"	1.500"	18	0.0478	6.03	95	1.10
		16	0.0598	6.03	91	1.37
		14	0.0747	6.03	91	1.69
1 3/4"	1.750"	20	0.0359	6.03	69	0.98
		18	0.0478	6.03	69	1.29
		16	0.0598	6.03	91	1.61
1 7/8"	1.875"	14	0.0747	6.03	61	1.99
		20	0.0359	6.40	95	1.05
		12	0.1046	6.03	50	2.94
2"	2.000"	20	0.0359	6.40	67	1.12
		18	0.0478	6.03	67	1.48
		16	0.0598	6.03	61	1.84
		14	0.0747	6.03	61	2.29
2 1/8"	2.125"	14	0.0747	6.03	61	2.43

TUBERÍAS



• Para factibilidad en diferentes calibres, longitudes y acabados pregunte a su asesor de ventas.

Tubería Redonda

Descripción	Dim (in)	Calibre (in)	Espesor (in)	Longitud (m)	Pzas x paquete	Kg x m
2 1/4"	2.250"	18	0.0478	6.03	60	1.67
		16	0.0598	6.03	61	2.08
		14	0.0747	6.03	61	2.58
2 1/2"	2.500"	18	0.0478	6.03	60	1.86
		16	0.0598	6.03	60	2.32
2 3/4"	2.750"	14	0.0747	6.03	61	2.88
		11	0.1196	6.03	30	5.00
3"	3.000"	18	0.0478	6.03	39	2.24
		16	0.0598	6.03	39	2.79
3 1/2"	3.500"	14	0.0747	6.03	37	3.47
		13	0.0897	6.03	19	4.86
4 1/2"	4.500"	1/4	0.25	6.03	19	12.91
		1/4	0.2500	6.03	19	16.89

REJILLA ELECTROFORJADA

Tipo	Pulgadas	Tipo	Pulgadas
IS-05	1/8 X 3/4"	IS-05	3/16 x 1-1/4"
IS-05	1/8 X 1"	IS-05	3/16 x 1-1/2"
IS-05	1/8 X 1- 1/4"	IS-05	3/16 x 1-3/4"
IS-05	1/8 X 1- 1/2"	IS-05	3/16 x 2"
IS-05	3/16 x 3/4"	IS-05	3/16 x 2-1/4"
IS-05	3/16 x 1"	IS-05	3/16 x 2-1/2"



PESO NOMINAL DE LA REJILLA ELECTROFORJADA DE ACERO

Solera de Carga

mm	pulgada	IS-01 kg/m2	IS-02 kg/m2	IS-03 kg/m2	IS-04 kg/m2	IS-05 kg/m2
3.2 x 19.1	1/8 x 3/4"	26.2	29.1	22.9	25.8	19.1
3.2 x 25.4	1/8 x 1"	33.9	36.9	29.5	32.4	24.4
3.2 x 31.8	1/8 x 1-1/4"	41.7	44.6	36.1	39.1	29.8
3.2 x 38.1	1/8 x 1-1/2"	49.4	52.4	42.8	45.7	35.2
4.8 x 19.1	3/16 x 3/4"	37.8	40.7	32.8	35.8	27.1
4.8 x 25.4	3/16 x 1"	49.4	52.4	42.8	45.7	35.2
4.8 x 31.8	3/16 x 1-1/4"	61.1	64	52.7	55.7	43.3
4.8 x 38.1	3/16 x 1-1/2"	72.7	75.6	62.7	65.7	51.3
4.8 x 44.4	3/16 x 1-3/4"	84.6	87.8	72.9	76.2	59.7
4.8 x 50.8	3/16 x 2"	96.2	99.4	82.9	86.1	67.7
4.8 x 57.1	3/16 x 2-1/4"	107.8	111	92.9	96.1	75.8
4.8 x 63.5	3/16 x 2-1/2"	119.4	122.6	102.8	106	83.9

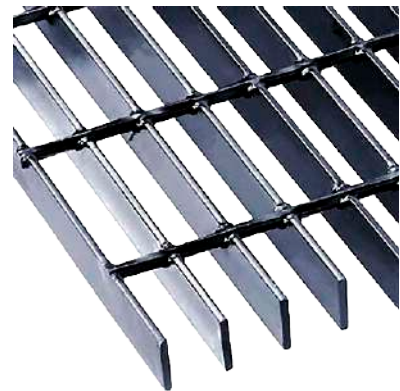

» Galvanizado por inmersión caliente según las normas ASTM-A123
 Tamaño del tablero: 1.00 x 6.00 m Superficie: Lisa y Dentada

- AN - Acero al Natural
- PNBA - Pintura Negra Base Agua
- *Sobre pedido

VARILLA R-42

Usos:

- Castillos y cerramientos
- Vigas y columnas
- Losas sólidas y aligeradas

Características:

- Presentación recta y doblada
- Variedad de diseños
- Fabricadas con la más alta tecnología

Ventajas:

- Tener mayor adherencia al concreto
- No están aceradas
- 3/8" y 1/2" se pueden vender en paquetes de 10 piezas

» Marca de identificación R-42

Díámetro	Presentación	Largo	Aprox por Tonelada
plg		m	
3/8"	Recta	9.15	---
3/8"	Recta	12	250
1/2"	Recta	9.15	---
1/2"	Recta	12	150
5/8"	Recta	12	100
3/4"	Recta	12	70
1"	Recta	12	40
1 1/4"	Recta	12	24
1 1/2"	Recta	12	16

*Sobre pedido



CASTILLO

Usos:

- Armado de columna y cerramientos
- Refuerzo en losas
- Confinar a los muros para evita que se agrieten

Características:

- Ahorro del 50% en material y mano de obra
- Hecho con varillas longitudinales de acero laminadas en frío de grado 60
- Estribos lisos laminados en frío de grado 50
- Marca de identificación DA60

» Presentación en hojas y doblado

Diseño	Presentación	Calibre	Largo
			m
15 x 15 ~ 4	Hojas	1/4"	6.0
15 x 20 ~ 4	Hojas	1/4"	6.0
15 x 15 ~ 3	Hojas	1/4"	6.0
15 x 30 ~ 4	Hojas	1/4"	6.0
15 x 12 ~ 4	Hojas	1/4"	6.0
15 x 15 x 4	Hojas	1/4"	6.0
15 x 20 x 4	Hojas	1/4"	6.0



Ventajas:

- Fácil manejo, transporte y almacenamiento
- Castillo T2 Varilla 5/16

ALAMBRE RECOCIDO

Usos:

- Para amarrarse en armados de castillo, armado de losas, armados de zapatas, entre otras

Características:

- Misma suavidad a lo largo del alambre

Ventajas:

- Mejor calidad del recocido
- Menor suciedad al momento de trabajarlo

» Más maleabilidad

Calibre	Diámetro	Rendimiento	Peso en rollo
	mm	m / kg	kg
16	1.78	51.4	50 - 70



ALAMBRÓN

Usos:

- Construcción

Características:

- Resistencia a la tensión se encuentra
- Contiene entre 38 kg/mm² y 130 kg/mm²

» 98% del alambrrn se usa para fabricar estribo

Diámetro		Peso
plg	mm	kg/m
1/4	6.35	0.248

Ventajas:

- Los rollos cuentan con 4 flejes de alambrrn distribuidos en 4 puntos equidistantes
- Cuentan con una etiqueta de identificación sujeta a uno de los extremos del rollo



MALLA ELECTROSOLDADA FERRETERA

Usos:

- Para fabricar pisos, muros, losas de cimentación, pavimentos entre otros

Características:

- Fabricada con varilla corrugada de acero grado 50 laminada en frío

» Ideal para su manejo en ferreterías

Diseño	Calibre	Altura	Largo	m ²
		m	m	
66.1010	10	1.22	20	25
66.1010	10	2.50	40	100



Ventajas:

- Ahorro en tiempo
- Reducción de desperdicio
- Malla banquetera

ARMADURA

Usos:

- Fabricación de viguetas
- Semi prefabricadas de concreto (viguetas y bovedilla)

Características:

- En cumplimiento de las normas NMX

Ventajas:

- Ahorro hasta 85% en la cimbra de la losa
- Ahorro en mano de obra para habilitado de acero de refuerzo
- Eliminación de cimbra de contacto

ESPECIFICACIONES DE LA ARMADURA

Resistencia mínima a la tensión Varilla Grado 60	7,000 kg/cm ²
Resistencia mínima a la tensión Varilla Grado 60	6,000 kg/cm ²
Alargamiento a la ruptura en 10 O Grado 60	5%
Resistencia mínima a la tensión Varilla Grado 50	5,700kg/cm ²
Resistencia mínima a la fluencia Varilla Grado 50	5,000kg/cm ²
Alargamiento a la ruptura en 10 O Grado 60	6 %

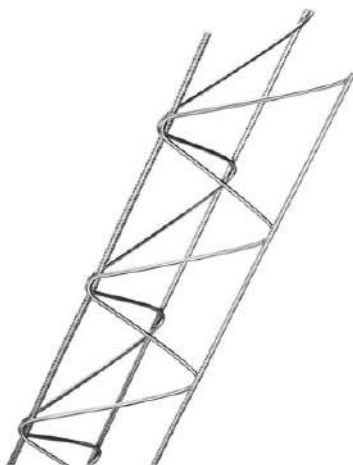

Diseño	Altura	Diam varillas interiores	Áreas varillas interiores	Largo
	cm	mm	mm ²	m
10-36	10	4.76	36	6.0
12-36	12	4.76	36	6.0
12-64	12	6.35	64	6.0
14-36	14	4.76	36	6.0
14-36	14	4.76	36	7.0
14-36	14	4.76	46	9.0
14-64	14	6.35	64	6.0
14-64	14	6.35	64	7.0
14-64	14	6.35	64	9.0

ESCALERILLA

Usos:

- Refuerzo horizontal en muros de mampostería
- Complemento de refuerzo en los castillos

Características:

- Tramos de 3 mts de largo
- Alambre calibre 10
- Soldadura por resistencia eléctrica

Ventajas:

- Soldado uniforme y limpio
- Corrector alargamiento a la ruptura
- Alata resistencia a la fluencia

ESPECIFICACIONES DE LA ESCALERILLA

Grado de varilla	G50
Resistencia a la tensión	5,700 kg/cm ²
Resistencia a la fluencia	5,000kg/cm ²
Alargamiento a la ruptura	6 % en 10

Clave	Diseño	Ancho	Separación	Calibre	Largo
		cm	mm	mm ²	m
38125	10-2	7	25	10	3
38126	12-2	9	25	10	3
38127	15-2	12	25	10	3



TABLA DE EQUIVALENCIAS Y CONVERSIÓN DE UNIDADES

calibre	milésima	pulgadas	milésima	mm
4	0.225	1/16	0.062	1.58
6	0.195	1/8	0.125	3.17
7	0.180	5/32	0.156	3.96
8	0.165	3/16	0.187	4.76
9	0.150	1/4	0.250	6.35
10	0.135	5/16	0.312	7.93
11	0.120	3/8	0.375	9.52
12	0.105	7/16	0.437	11.11
13	0.090	1/2	0.500	12.70
14	0.075	9/16	0.562	14.28
16	0.060	5/8	0.625	15.87
18	0.048	11/16	0.687	17.46
20	0.036	3/4	0.750	19.05
22	0.030	13/16	0.812	20.63
24	0.024	7/8	0.875	22.22
26	0.018	15/16	0.937	23.81
28	0.015	1	1.000	25.40

pies	pulgadas	mts	para convertir pulgadas a mts
1	12	0.305	Pulgadas X 2.54 = cms / 100 = mts Ejem: 120" X 2.54 = 304.80 / 100 = 3.05mt 39.37" X 2.54 = 100 / 100 = 1mt
2	24	0.610	
3	36	0.914	
4	48	1.219	Para convertir Mts a Pulgadas (debemos manejarlo en cm) 1 mt = 100 cm / 2.54 = 39.37"
5	60	1.524	
6	72	1.829	Ejem: 3.05mt X 100 = 350cm / 2.54 = 120" 1.00mt X 100 = 100cm / 2.54 = 39.37"
7	84	2.134	
8	96	2.438	Formula para Peso Teórico: Espesor en Pulgadas (ó milésimas) X Ancho en Pulgadas X Largo en Pulgadas X .13
9	108	2.743	
10	120	3.050	
12	144	3.658	
15	180	4.572	
20	240	6.100	
30	360	9.144	
40	480	12.192	
42	504	12.800	
50	600	15.240	

TABLA DE EQUIVALENCIAS Y CONVERSIÓN DE UNIDADES

Fracciones a decimales de pulgadas y a milímetros					
fracc pulg	decimales pulg	mm	fracc pulg	decimales pulg	mm
1/64	0.015625	0.39688	33/64	0.515625	13.09693
1/36	0.03125	0.79375	17/32	0.531250	13.49380
3/64	0.046875	1.19063	35/64	0.546875	13.89068
1/16	0.0625	1.58751	9/16	0.562500	14.28756
5/64	0.078125	1.98438	37/64	0.578125	14.68443
3/32	0.09375	2.38126	19/32	0.593750	15.08131
7/64	0.109375	2.77814	39/64	0.609375	15.47819
1/8	0.125	3.17501	5/8	0.625000	15.87506
9/64	0.140625	3.57189	41/64	0.640625	16.27194
5/32	0.15625	3.96877	21/32	0.656250	16.66882
11/64	0.17185	4.36564	43/64	0.671875	17.06569
3/16	0.1875	4.76252	11/16	0.687500	17.46257
13/64	0.203125	5.15940	45/64	0.703125	17.85945
7/32	0.21875	5.55627	23/32	0.718750	18.25632
15/64	0.234375	5.95315	47/64	0.734375	18.65320
1/4	0.25	6.35003	3/4	0.750000	19.05008
17/64	0.265625	6.74690	49/64	0.765625	19.44695
9/32	0.28125	7.14378	25/32	0.781250	19.84383
19/64	0.296875	7.54065	51/64	0.796875	20.24070
5/16	0.3125	7.93753	13/16	0.812500	20.63758
21/64	0.328125	8.33441	53/64	0.828125	21.03446
11/32	0.34375	8.73128	27/32	0.843750	21.43133
23/64	0.359375	9.12816	55/64	0.859375	21.82821
3/8	0.375	9.52504	7/8	0.875000	22.22509
25/64	0.390625	9.92191	57/64	0.890625	22.62196
13/32	0.40625	10.31879	29/32	0.906250	23.01884
27/64	0.421875	10.71567	59/64	0.921875	23.41572
7/16	0.4375	11.11254	15/16	0.937500	23.81259
29/64	0.453125	11.50942	61/64	0.953125	24.20947
15/32	0.46875	11.9063	31/32	0.968750	24.60635
31/64	0.484375	12.30317	63/64	0.984375	25.00322
1/2	0.5	12.70005	1	1.000000	25.40010

Síguenos: [f](#) [@](#) [t](#)

*Insumos, herramientas y
accesorios para el acero*

FERRETERÍA HERRAMIENTAS Y ACCESORIOS



Alambres | Mallas y Cercos | Ferrería y Accesorios de Acero
Material para Tejabán | Equipo de Seguridad



FIERRO Y ACERO
COFIASA



FIERRO Y ACERO
COFIASA



EFFECTIVO



**TARJETA DE
CRÉDITO/DÉBITO**

FORMAS DE PAGO



**TRANSFERENCIA
ELECTRÓNICA**



C.O.D



CHECK PLUS



CHEQUE



MSI



MEJORAVIT



TERMINAL

ESCANEA Y MIRA NUESTROS CATÁLOGOS

www.cofiasa.com.mx



escaneame



CATÁLOGO DE ACERO •

Aquí tenemos nuestro catálogo de materiales de acero donde encontraras nuestra gran variedad de productos.



CATÁLOGO DE FERRETERÍA •

En este catálogo encontraras el gran surtido de materiales y productos de ferretería para tu negocio.



FIERRO Y ACERO
COFIASA

Formas de pago:

**3y6
MESES**
SIN INTERESES

Mejoravit



Check plus



TERMINAL

Síguenos en:   

www.cofiasa.com.mx



FIERRO Y ACERO

COFIASA

¿ERES CLIENTE FRECUENTE?

Regístrate y Obtén
Ya tu tarjeta



¡ACUMULA COFI-PESOS!

-Acumula **1 Cofi-Pesos** por cada \$100 pesos de compras que hagas (sin IVA).

-¡Ahorra y cambia por más material, el que tú quieras!

-Deberás presentar tu tarjeta o mencionar el folio y número del cliente.





*Aplican Restricciones

Para mayor información

www.cofiasa.com.mx/club-cofi-pesos



www.cofiasa.com.mx

Síguenos en:   

SUCURSALES

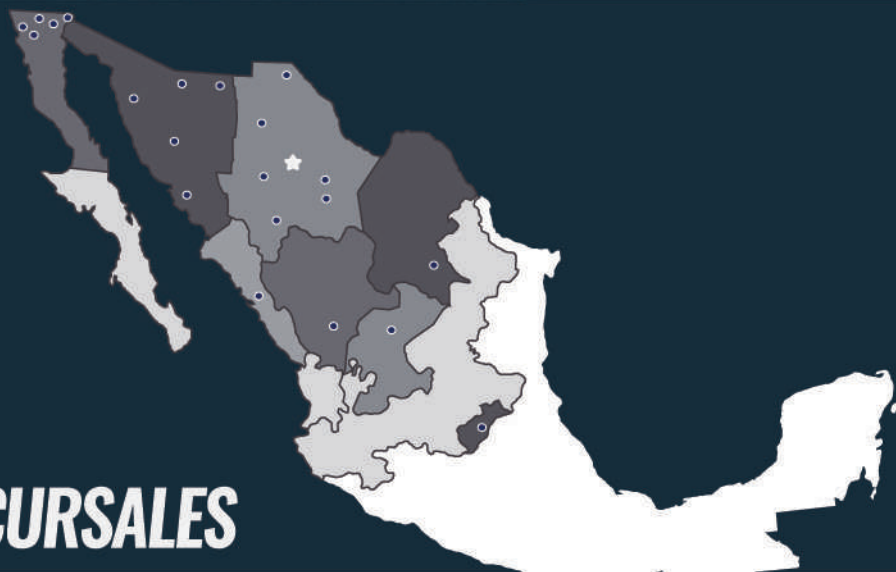

CHIHUAHUA

CORPORATIVO	(614) 442-10-41
CHIHUAHUA MATRIZ	(614) 442-10-40
DALE	(614) 492-00-33
VILLA	(614) 419-47-04
Z A R C O	(614) 411-50-32
NUEVA ESPAÑA	(614) 420-80-23
CHIHUAHUA NORTE	(614) 483-26-21
CHIHUAHUA AEROPUERTO	(614) 446 5068

EDO. CHIHUAHUA

DELICIAS	(639) 472-52-22
DELICIAS SUR	(639) 474-59-19
CAMARGO	(648) 462-39-66
NVO. CASAS GRANDES	(636) 694-21-18
PARRAL	(627) 523-06-31
CUAUHTÉMOC	(625) 582-01-24
CUAUHTÉMOC CENTRO	(625) 128-07-46

QUERÉTARO

QRQ. CARRETERA CELAYA	(442) 195-62-39
QRQ. SAN JOSÉ	(442) 210-22-39

JUÁREZ

JUÁREZ NORTE	(656) 615-34-04
JUÁREZ CENTRO	(656) 227-71-11
JUÁREZ TORRES	(656) 624-41-71
JUÁREZ AZTECAS	(656) 630-26-85
JUÁREZ LIBRAMIENTO	(656) 683-65-44
JUÁREZ GRANJERO	(656) 693-28-48
JUÁREZ SUR	(656) 620-51-47
JUÁREZ SANTA CLARA	(656) 229-63-89

SONORA

HERMOSILLO PROGRESO	(662) 264-54-34
HERMOSILLO SUR	(662) 688-85-30
AGUA PRIETA	(633) 331-00-72
OBREGÓN	(644) 412-00-82
CABORCA	(637) 372-72-30
NOGALES TECNOLÓGICO	(631) 313-54-50

DURANGO

DURANGO FCO. VILLA	(618) 833-01-02
--------------------	-----------------

ZACATECAS

FRESNILLO	(493) 935-75-64
-----------	-----------------

TIJUANA

TIJUANA MATAMOROS	(664) 645-79-71
TIJUANA S Y 10	(664) 626-14-07
TIJUANA FUNDADORES	(664) 637-97-20
TIJUANA FLORIDO	(664) 645-04-22
TIJUANA SOLER	(664) 630-58-21
TIJUANA BUENOS AIRES	(664) 905-89-41
ROSARITO	(661) 613-41-27

BAJA CALIFORNIA

ENSENADA	(646) 177-36-79
MEXICALI	(686) 561-84-60
MEXICALI PALACO	(686) 577-81-56
TECATE	(665) 654-64-61

SINALOA

CULIACÁN TRES RIOS	(667) 764-22-62
CULIACÁN ABASTOS	(667) 749-33-44

COAHUILA

SALTILLO NORTE	(844) 485-13-07
SALTILLO FUTURA	(844) 112-87-47